



WARNINGS:

- Always unplug unit before attempting to service.
- Never spray flammable material.
- Do NOT operate near flammable materials.
- Use only original manufacturer parts.
- Do NOT modify from original specifications.
- Replace damaged hoses immediately.
- Always wear protective clothing and eye wear when operating.
- Release pressure before disconnecting spray control gun and spray wand.
- Disconnect or unplug unit when not in use.
- Never immerse pump.

Pump will not start:

- Check the circuit breaker
 - Check for proper voltage (+/-10%) & good electrical connections
 - Check pressure switch for proper operation
 - Check motor for an open or grounded circuit
 - Check for a locked drive assembly
- Leaks from pump head or switch:**
- Check for loose screws at the switch or pump head
 - Switch diaphragm may be torn or pinched

Noisy or Rough Operation:

- Check for loose upper housing or drive screws
- Is the surface that the pump is sitting on magnifying the normal noise

Pump will not prime:

- Out of product
- Check for debris in strainer
- Check for vacuum leak in suction hose
- Check suction tube and outlet hose for kinks or clogs
- Check for debris in valve plate
- Check for proper operating voltage (+/-10%) with the pump operating
- Check upper housing for cracks
- Be sure spray control handle and spray tip are open and free of debris
- If pump has been sitting try turning the unit upside down and pour water into the suction hose or attach a garden hose to the suction hose and turn the garden hose on. Then turn the unit on. This procedure will force water thru the valves and free them if they are sticking.

Pump will not shut off:

- If recirculator is installed it will need to be adjusted to 175psi for the pressure switch to operate
- Check that the outlet hose is closed and does not leak
- Check for trapped air in the head or outlet hose
- Check for proper operating voltage (+/-10%) to pump
- Check valve assembly for wear
- Check for loose drive assembly or upper housing screws
- Check pressure switch to verify it has not moved out of adjustment

If you have any questions regarding the use or repair of this product please feel free to contact Customer Support by telephone: 800.801.7832 – 847.639.7272 or via email: support@4progressive.com.

PN:01095

DIRECTIONS FOR USE:

- 1) Position the unit on top of the container you wish to dispense from and insert the suction hose. The brass suction nozzle has been threaded so that a garden hose may be connected to lengthen the suction line or give the operator the ability to spray water. The maximum vertical self prime is 15 feet.
- 2) Check the switch to be sure it is in the "OFF" position, then connect the power source.
 - AC - Insert the plug into a grounded outlet.
 - DC - Connect the RED (+) clamp to the positive battery terminal. Then connect the BLACK (-) clamp to a grounded metal portion of the chassis or engine. For stand alone battery applications the BLACK (-) clamp may be connected directly to the negative battery terminal.
- 3) Squeeze the spray control gun or remove the spray control gun. Insert end into container. Move switch to the "ON" position and allow the unit to prime.
- 4) When primed, move switch to "OFF" and connect the spray control gun and wand if not already connected. If the product must be circulated before spraying, leave unit "ON" with hose or wand end in the container and allow product to circulate. *A bypass is available for products that need to be continuously circulated.

FOR USE WITH ALL
Spray 'N' Pail
POWER SPRAYERS









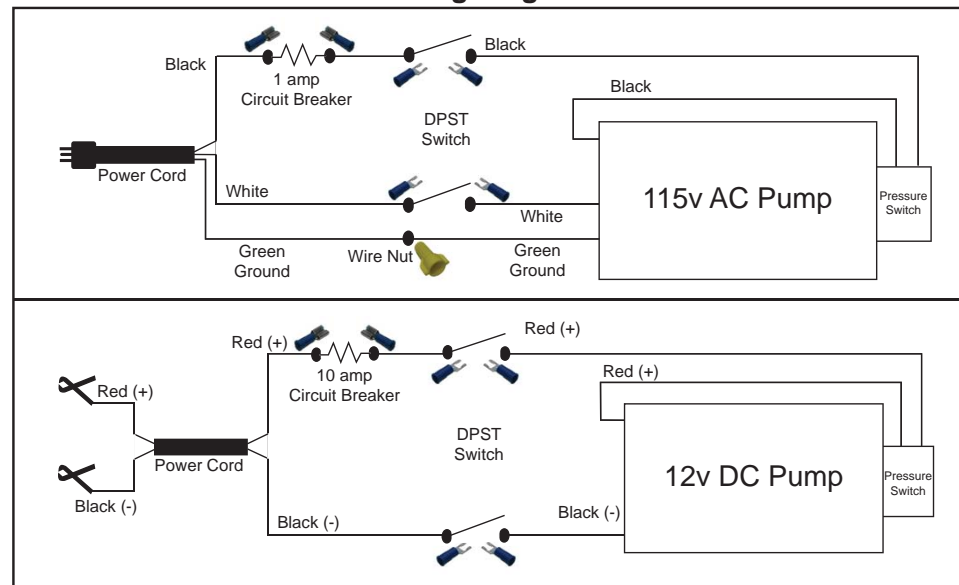

DIRECTIONS FOR CLEANING: *MUST BE CLEANED AFTER EVERY USE!*

- 1) After spraying, remove the suction hose from the container. Insert the wand end into the container and hold the spray control gun in the OPEN position. Allow the unit to expel the unused material back into the container. The wand and the spray tip are left attached for this process to provide a back pressure that will help expel 90% of the unused material out of the unit.
- 2) Then circulate either soap and water or other recommended cleaning solution through the unit until it comes out clean and clear. NEVER USE STRAIGHT XYLENE. Soap and water or diesel are best.
- 3) Drain all liquid from the pump. Do NOT allow liquid to freeze in the pump. Failure to do this will result in damage to the internal components of the pump. In freezing conditions, draw some windshield washer fluid or diesel into the pump to protect against freezing.

Wiring Diagrams







Pail / Hose Parts

Qty	PN	Description	
1	01093	50' Yellow Chem Hose	
1	01020	Female Quick Connect	
1	01031	5/8" Two Ear Clamp	
1	01098	Empty Black Pail	
1	01099	Orange Lid	
2	01010	10/24 x 1" Bolt	
2	01012	10/24 Nylon Lock Nut	
2	01028	3/16 x 1" Flat Washer	

FOR USE WITH ALL
Spray 'N' Pail
POWER SPRAYERS



Optional Parts & Kits

Qty	PN	Description	
1	01016	Strainer - Large Chrome (use w/01062)	
1	01062	MGHT x MGHT Brass (use w/01016)	
1	67000	Recirculator Kit	
1	69101	100' Hose Extension Kit PNs: 01018, 01020, (2)01031, 01019, 01034	
1	69102	100' Hose Replacement Kit PNs: 01018, 01020, 01031, 01060	

Motor Cover Parts

Qty	PN	Description	
1	01097	Pump Cover	
1	01005	AC/DC ON/OFF Switch	
1	01006	ON/OFF Indicator Plate	
1	01021	Anti-Strain Cord Lock	
1	01024	9' AC Power Cord w/ Plug	
1	01026	Positive Bat Clip DC - red	
1	01027	Negative Bat Clip DC - black	
1	01090	Circuit Breaker 10amp - DC	
1	01091	Circuit Breaker 1amp - AC	
1	01092	Circuit Breaker - Slip On Cover	
1	01100	25' DC Power Cord w/ Clips	

Spray Control Parts

Qty	PN	Description	
1	64000	12" Straight Wand	
1	64010	12" Curved Wand	
1	65120	1 gpm Brass Fan Tip	
1	65110	0.5 gpm Brass Fan Tip	
1	61012	1/4 MPT x 1/4 MPT	
1	61013	Male Connect - 3/8" MPT	
1	66100	Spray Ctrl Gun w/ QC	











ATTENTION
Knock Out Plug Instructions

Before using your new Spray 'N' Pail for the first time you must perform the following two steps.

1. Lay the pail on its side and locate the knock out plug in the bottom of the pail.
2. Firmly strike the knockout plug with a hammer or other similar tool. This will cause the plug to pop out.

You may now feed the suction line through the bottom of the pail. Your Spray 'N' Pail is ready to use.

Pump / Suction Parts

Qty	PN	Description		Qty	PN	Description	
1	01002	115v AC Pump Complete		1	01041	Twist On Wire Cnnctr (AC)	
1	01003	12v DC Pump Complete		2	01040	Elec Female Term Cnnctr	
4	01009	10/24 x 1 1/4 Bolt		1	01063	Pressure Swtch Assm	
4	01012	10/24 Nylon Lock Nut		1	01064	Check Valve Components	
1	01015	3' 10" Suction Hose		1	01065	Upper Housing	
1	01102	Brass Suction Nozzle		1	01066	Valve Plate Assembly	
1	01101	Screen - Suction Nozzle		1	01067	Std Diap/Piston Cmpts	
1	01103	3/8 Quick Cnnct x 3/8 Barb		1	01068	Water Only Diap/Pstn Cmpts	
1	01104	3/8 Quick Cnnct x 1/2 Barb		1	01069	Oil Only Diap/Piston Cmpts	
1	01031	5/8 Two Ear Clamp		1	01070	Drive Assembly	
2	01032	3/4 Two Ear Clamp		1	01071	115v AC Motor Only	
4	01039	Elec Spade Terminal Cnnctr		1	01072	12v DC Motor Only	